

9225 92x92x25mm

General Specifications

- ◆ Material..... Frame: Die-Casting aluminum painted black, Impeller: PBT (UL94V-0)
- ◆ Motor Shaded pole
- ◆ Protection..... Impedance protection or thermal protection
- ◆ Dielectric Strength..... 50/60Hz 1500VAC 1min (Between input terminal and frame)
- ◆ Temperature Range.... Operating temperature ball bearing -40°C~70°C (Non-condensing)
Sleeve bearing -20°C~70°C (Non-condensing)
- ◆ Expected Life..... Ball bearing 50,000hrs at 40°C , Sleeve bearing 30000hrs at 40°C
- ◆ Safety Approval..... UL,CUL,CE,TUV



Specifications

Model	Rated Voltage	Freq	Input Current	Input Power	Speed	Max Air Flow		Max Static Pressure		Noise	Weight	Curve
Part No.	VAC	Hz	Amp	Watt	RPM	CFM	m ³ /min	Inch-H ₂ O	Pa	dB-A	g	
AA09225B11HL(T)	110	60	0.15	15	2850	37.35	1.06	0.19	47.31	36.2	270	1
AA09225S11HL(T)	110	60	0.15	15	2750	36.21	1.03	0.18	44.82	35.2	270	2
AA09225B22HL(T)	220	50	0.08	17	2350	23.78	0.67	0.13	32.37	32.0	270	3
AA09225S22HL(T)	220	50	0.08	17	2250	22.49	0.64	0.12	29.88	31.0	270	4

All model could be customized on voltage or any other requirements to fit your need.

Note: "11" is 110 VAC, "22" is 220 VAC, (L) is Leadwire, (T) is Terminal

Dimensions (Unit:mm)

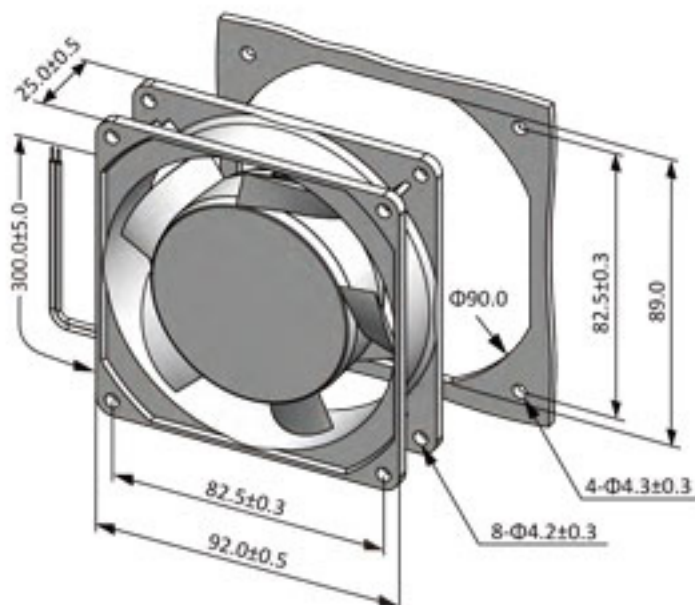

PQ Curve (At Rated Voltage)

